

CE Series

Heavy Duty Cylindrical Lockset



Available Lever Styles



Sentinel(S)



Quest(Q)



Gala(G)



Wolfsburg(W)



Wolfsburg R(WR)

Specifications:

Finish	619 (US15), 622 (US19), 626 (US26D) stocked or special color upon request
Lever Style	Sentinel, Quest or Gala
Backset	2-3/4", 2-3/8" or 5"
Cylinder	Key in option with Schlage® 6-pin, Kwikset® 6-pin, High security 6-pin, Best® 6-pin, IC core, Best® 7-pin, IC core; High security 7-pin, IC core, Less cylinder option with Schlage® small format IC, Schlage® large format IC, Corbin® large format IC
Lockbody	Clutched or Rigid
Function	ANSI F-75, 76, 77, 82, 84, 86, 87, 89, 90, 109
ANSI/BHMA A156.2	Grade 1 certified
Series 4000	
UL	UL 10C 3-hour rated
BAA	Meets guidelines of the Buy American Act
ADA	Meets requirements of the Americans with Disabilities Act



CE Series

Heavy Duty Cylindrical Lockset

Profile

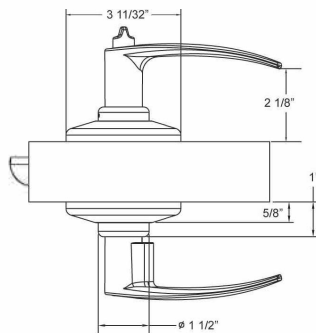

Gala

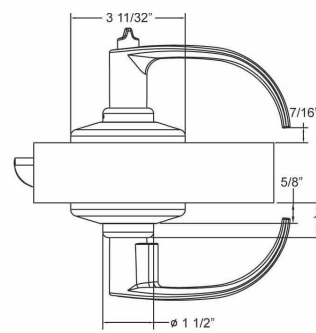

Quest

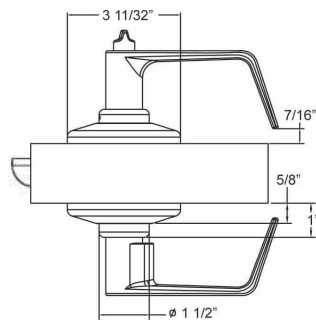

Sentinel

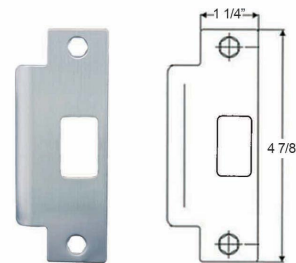

ASA Strike

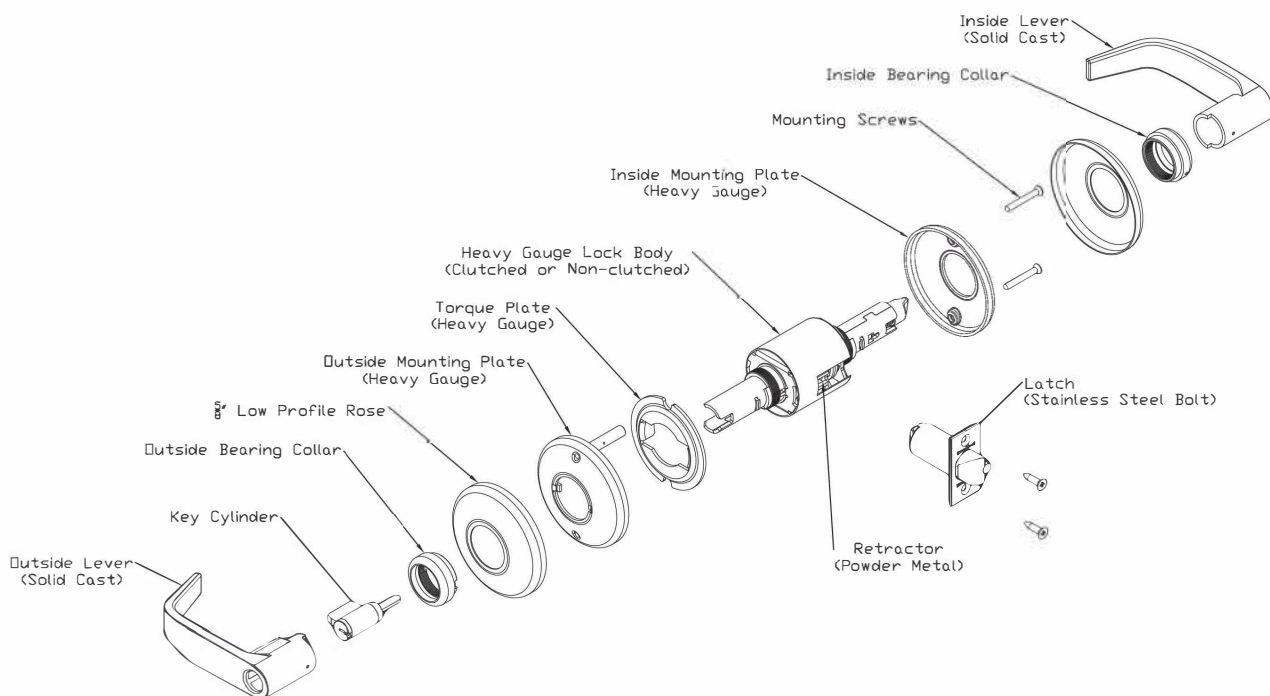

CE Series

Heavy Duty Cylindrical Lockset

How To Order

Series	Function	Lever Style	Finish	Cylinder	Backset
CE: Non-Clutch Trim	F75	S: Sentinel	619: US15, Satin Nickel	Cylinder Specifications Key in lever option: ▪ Blank: Schlage® 6-pin with "C" Keyway, standard ▪ K6: Kwikset® 6-pin with "KW" Keyway ▪ HS6: High security 6-pin with Townsteel "L" Keyway ▪ SF6: Best® 6-pin, IC core with "A" Keyway ▪ SF7: Best® 7-pin, IC core with "A" Keyway ▪ HS7: High security 7-pin, IC core with Townsteel "L" Keyway Other Less cylinder core option: ▪ SLF: Schlage® large format IC, SLFIC ▪ CLF: Corbin® large format IC, CLFIC *KD standard, KA, MK, GMK, GGMK upon request	2-3/8"
CEC: Clutched Trim	F76				
	F77				
	F82	Q: Quest	622: US19, Flat Black		
CEI: non- Clutched Trim	F84	G: Gala	626: US26D, Satin Chrome	▪ SLF: Schlage® large format IC, SLFIC ▪ CLF: Corbin® large format IC, CLFIC *KD standard, KA, MK, GMK, GGMK upon request	2-3/4"
	F86	W: Wolfsburg			
	F87	WR: Wolfsburg R			
CECI: Clutched Trim	F89		Or special color upon request	▪ Schlage® small format IC, SFIC, less cylinder core	5"
	F109				

Example:

CEC- 109 - S - 626 - SLF

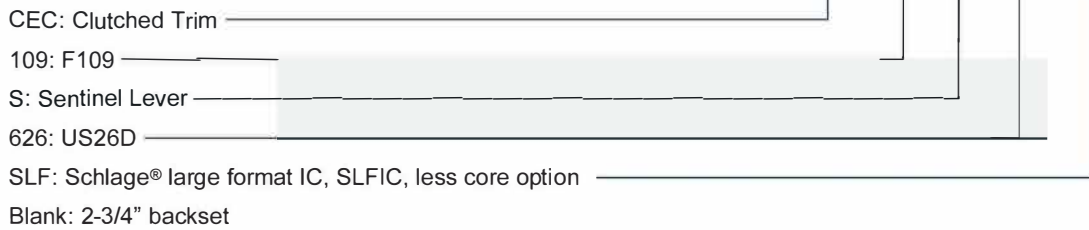

Example:

CEI- 109 - S - 626

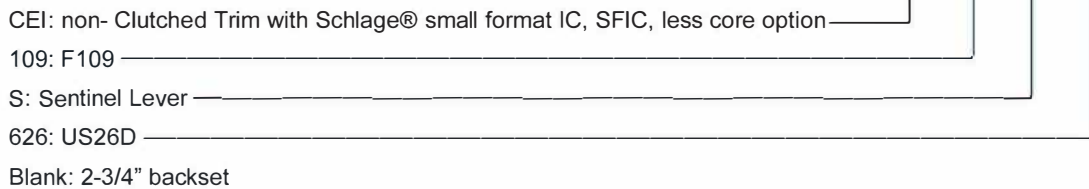





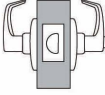
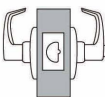
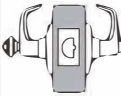
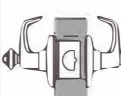
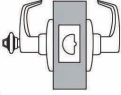
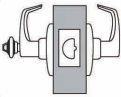

Cylindrical Lock Functions

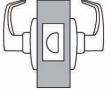
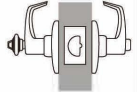
Functions

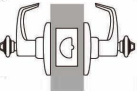
Outside	Inside	Series/ Function	Type	ANSI No.	Function Description
		CE-75 CD-75 CDC-75 CS-75 CSRC-75	Passage Closet	F75	Latchbolt operated by lever from either side at all times.
		CE-76 CEC-76 CD-76 CDC-76 CS-76 CSRC-76 CB-76	Privacy	F76	Latchbolt operated by lever from either side. Outside lever is locked by push button inside and unlocked by emergency release outside, rotating inside lever or closing door.
		CE-77 CEC-77	Patio	F77	Deadlocking latchbolt operated by lever from either side. Outside lever is locked by push button inside and unlocked by rotating inside lever or closing door.
		CS-81	Entry / Office	F81	Turn/Push button locking. Pushing and turning button locks outside lever requiring use of key until button is manually unlocked. Pushing button locks outside lever until unlocked with key or inside lever is turned.
		CSRC-82 CB-82	ENTRANCE / OFFICE LOCK	F82	Dead locking latchbolt operated except when outside lever is locked by push button or other locking device on inside. When outside lever is locked, operating key in outside lever or operating inside lever unlocks push button or other locking device and retracts latch bolt. Closing door does not release push button or other locking device.
		CS-84 CE-84 CEC-84 CD-84 CDC-84 CSRC-84 CB-84	Classroom	F84	Deadlocking latchbolt operated by lever from either side except when both levers are locked from outside by key. When outside lever is locked, latchbolt is operated by key in outside lever or by rotating inside lever.
		CS-86 CE-86 CEC-86 CDC-86 CSRC-86 CB-86	Storeroom	F86	Deadlocking latchbolt operated by key in outside lever or rotating inside lever. Outside lever is always fixed.

Cylindrical Lock Functions

Functions					
Outside	Inside	Series/ Function	Type	ANSI No.	Function Description
		CE-87 CDC-87 CD-87 CS-87 CSRC-87	Asylum	F87	Deadlocking latchbolt operated by key in lever from either side. Both lever always inoperable.
		CE-89	Exit Latch	F89	Deadlocking latchbolt by leve from inside at all times. Outside lever is always inoperable.
		CD-90 CDC-90	CORRIDOR LOCK	F90	Dead locking latch bolt operated by lever from either side except when outside lever is locked by key in outside lever or by p push button or other locking device on inside. Key in outside lever locks or unlocks outside lever. Operating inside lever releases push button or other locking device placed position. Closing door releases push button or other inside locking device. Inside lever always operates latch bolt.
		CE-109 CEC-109 CD-109 CDC-109 CSRC-109 CB-109 CS-109	Entry / Office LOCK	F109	Dead locking latchbolt operated by lever from either side except when outside lever is locked by the push or turn button on inside. Key outside or operating inside lever releases push or turn button unlocking outside lever except when push or turn button has been roated to keep outside lever locked. Inside push or turn button must be mannullly operated to unlock outside lever. Inside lever always operates latch bolt.
		CDC-110 CD-110	INTRUDER CLASSROOM LOCK	F110	Dead locking latch bolt operated by lever from either side. Key either inside or outside locks or unlocks outside lever. Inside lever always operates latch bolt.
		CS-SD CD-SD CSRC-SD	Single Dummy		Single dummy trim for one side of door.
			Connecting Room / Exit		Deadlocking latchbolt operated from inside only. Blank plate outside.
			Connecting Room / Exit		Deadlocking latchbolt operated by lever from inside except when inside lever is locked by key. Blank plate outside.