

# CDC/CD Series

## Heavy Duty Cylindrical Lockset



Gala



Quest



Sentinel



### Specifications:

**Finish** 622 (US19), 626 (US26D) stocked or special color upon request

**Lever Style** Sentinel, Quest or Gala

**Backset** 2-3/4", 2-3/8" or 5"

**Rose Design** Wrought brass or stainless steel, 3-1/2" in diameter

**Cylinder** Key in option with Schlage® 6-pin, less cylinder option with Schlage® small format IC, Schlage® large format IC

**Lockbody** Clutched stocked or rigid upon request

**Function** ANSI F-75, 76, 82, 84, 86, 87, 90, 109, 110, Single Dummy, Pair Dummy

#### ANSI/BHMA A156.2

Grade 1 certified

#### Series 4000

**UL** UL 10C 3-hour rated

**BAA** Meets requirements of the Buy American Act

**ADA** Meets requirements of the Americans with Disabilities Act



# CDC/CD Series

## Heavy Duty Cylindrical Lockset

### Lever Profile

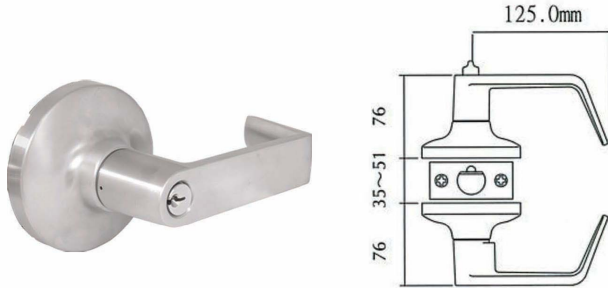

Sentinel(S)

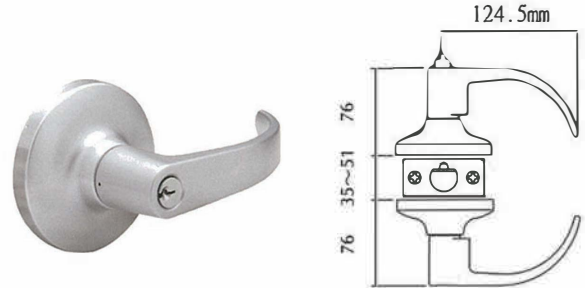

Quest(Q)

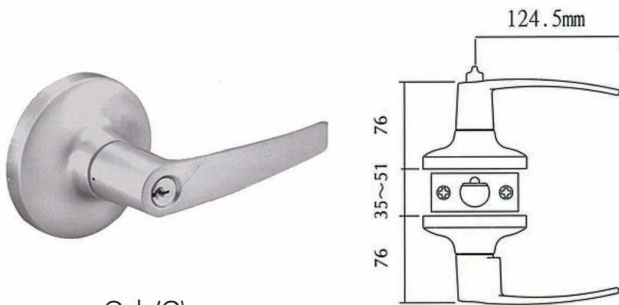

Gala(G)

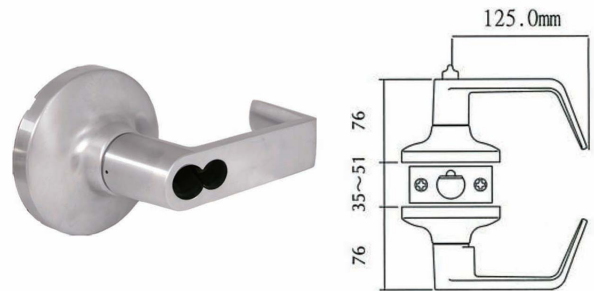

Schlage® LFIC  
(Available in Sentinel Lever Only)



ASA Strike

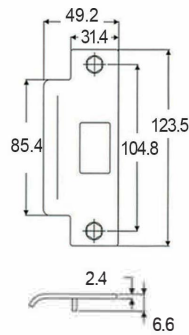

# CDC/CD Series

## Heavy Duty Cylindrical Lockset

### Lock Profile

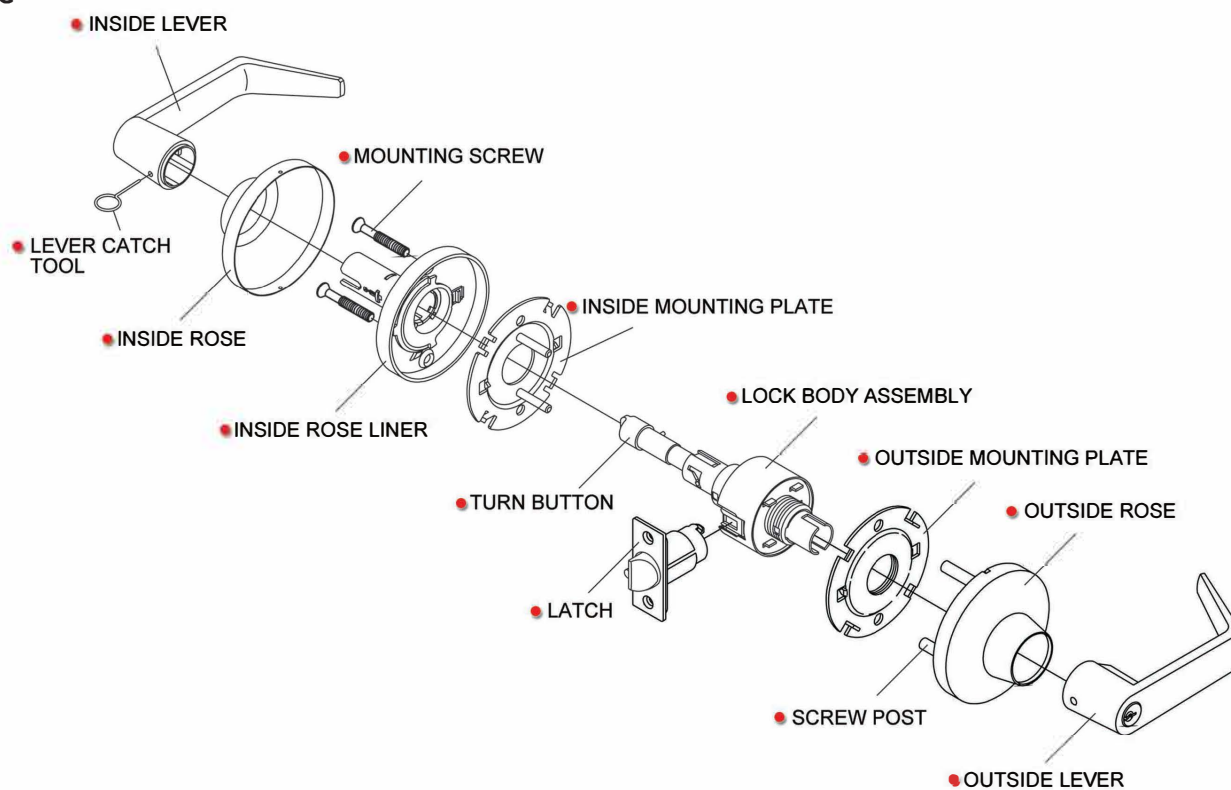

### How to Order

Series	Function	Lever	Finish	Backset
CD: non-Clutched Trim, Schlage® 6-pin with "C" Keyway, standard	F75	S: Sentinel	622: US19, Flat Black	Blank-2-3/4"
CDC: Clutched Trim, Schlage® 6-pin with "C" Keyway, standard	F76	Q: Quest		
CDCI: Clutched Trim, Schlage® small format IC, SFIC, less core option	F82	G: Gala	626: US26D, Satin Chrome	2-3/8"
	F84	*CDC-SLFIC		
	F86	only available	Or special color upon request	3-3/4"
	F87	with Sentinel		
	F90	lever		
CDC-SLFIC: Clutched Trim, Schlage® large format IC, SLFIC, less core option	F109			5"
	F110			
	SD			

#### Example:

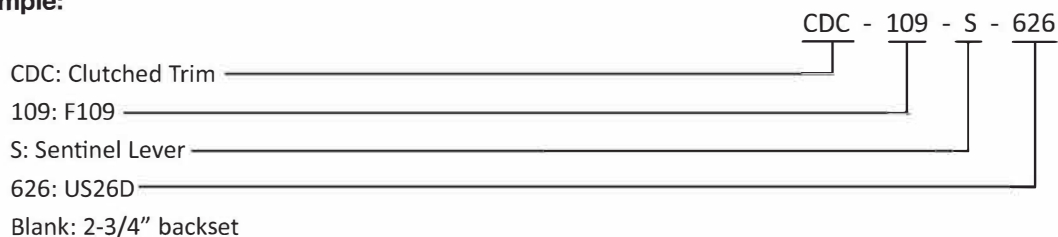





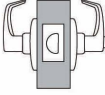
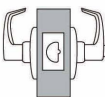
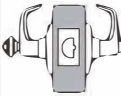
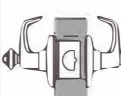
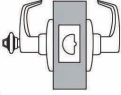
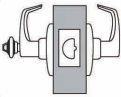

# Cylindrical Lock Functions

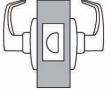
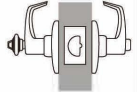
## Functions

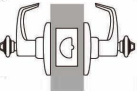
Outside	Inside	Series/ Function	Type	ANSI No.	Function Description
		CE-75 CD-75 CDC-75 CS-75 CSRC-75	Passage Closet	F75	Latchbolt operated by lever from either side at all times.
		CE-76 CEC-76 CD-76 CDC-76 CS-76 CSRC-76 CB-76	Privacy	F76	Latchbolt operated by lever from either side. Outside lever is locked by push button inside and unlocked by emergency release outside, rotating inside lever or closing door.
		CE-77 CEC-77	Patio	F77	Deadlocking latchbolt operated by lever from either side. Outside lever is locked by push button inside and unlocked by rotating inside lever or closing door.
		CS-81	Entry / Office	F81	Turn/Push button locking. Pushing and turning button locks outside lever requiring use of key until button is manually unlocked. Pushing button locks outside lever until unlocked with key or inside lever is turned.
		CSRC-82 CB-82	ENTRANCE / OFFICE LOCK	F82	Dead locking latchbolt operated except when outside lever is locked by push button or other locking device on inside. When outside lever is locked, operating key in outside lever or operating inside lever unlocks push button or other locking device and retracts latch bolt. Closing door does not release push button or other locking device.
		CS-84 CE-84 CEC-84 CD-84 CDC-84 CSRC-84 CB-84	Classroom	F84	Deadlocking latchbolt operated by lever from either side except when both levers are locked from outside by key. When outside lever is locked, latchbolt is operated by key in outside lever or by rotating inside lever.
		CS-86 CE-86 CEC-86 CDC-86 CSRC-86 CB-86	Storeroom	F86	Deadlocking latchbolt operated by key in outside lever or rotating inside lever. Outside lever is always fixed.

# Cylindrical Lock Functions

Functions					
Outside	Inside	Series/ Function	Type	ANSI No.	Function Description
		CE-87 CDC-87 CD-87 CS-87 CSRC-87	Asylum	F87	Deadlocking latchbolt operated by key in lever from either side. Both lever always inoperable.
		CE-89	Exit Latch	F89	Deadlocking latchbolt by leve from inside at all times. Outside lever is always inoperable.
		CD-90 CDC-90	CORRIDOR LOCK	F90	Dead locking latch bolt operated by lever from either side except when outside lever is locked by key in outside lever or by p push button or other locking device on inside. Key in outside lever locks or unlocks outside lever. Operating inside lever releases push button or other locking device placed position. Closing door releases push button or other inside locking device. Inside lever always operates latch bolt.
		CE-109 CEC-109 CD-109 CDC-109 CSRC-109 CB-109 CS-109	Entry / Office LOCK	F109	Dead locking latchbolt operated by lever from either side except when outside lever is locked by the push or turn button on inside. Key outside or operating inside lever releases push or turn button unlocking outside lever except when push or turn button has been roated to keep outside lever locked. Inside push or turn button must be mannully operated to unlock outside lever. Inside lever always operates latch bolt.
		CDC-110 CD-110	INTRUDER CLASSROOM LOCK	F110	Dead locking latch bolt operated by lever from either side. Key either inside or outside locks or unlocks outside lever. Inside lever always operates latch bolt.
		CS-SD CD-SD CSRC-SD	Single Dummy		Single dummy trim for one side of door.
			Connecting Room / Exit		Deadlocking latchbolt operated from inside only. Blank plate outside.
			Connecting Room / Exit		Deadlocking latchbolt operated by lever from inside except when inside lever is locked by key. Blank plate outside.