

m-Genius-c 4" CTC TEMPLATE 2 3/4" BACKSET

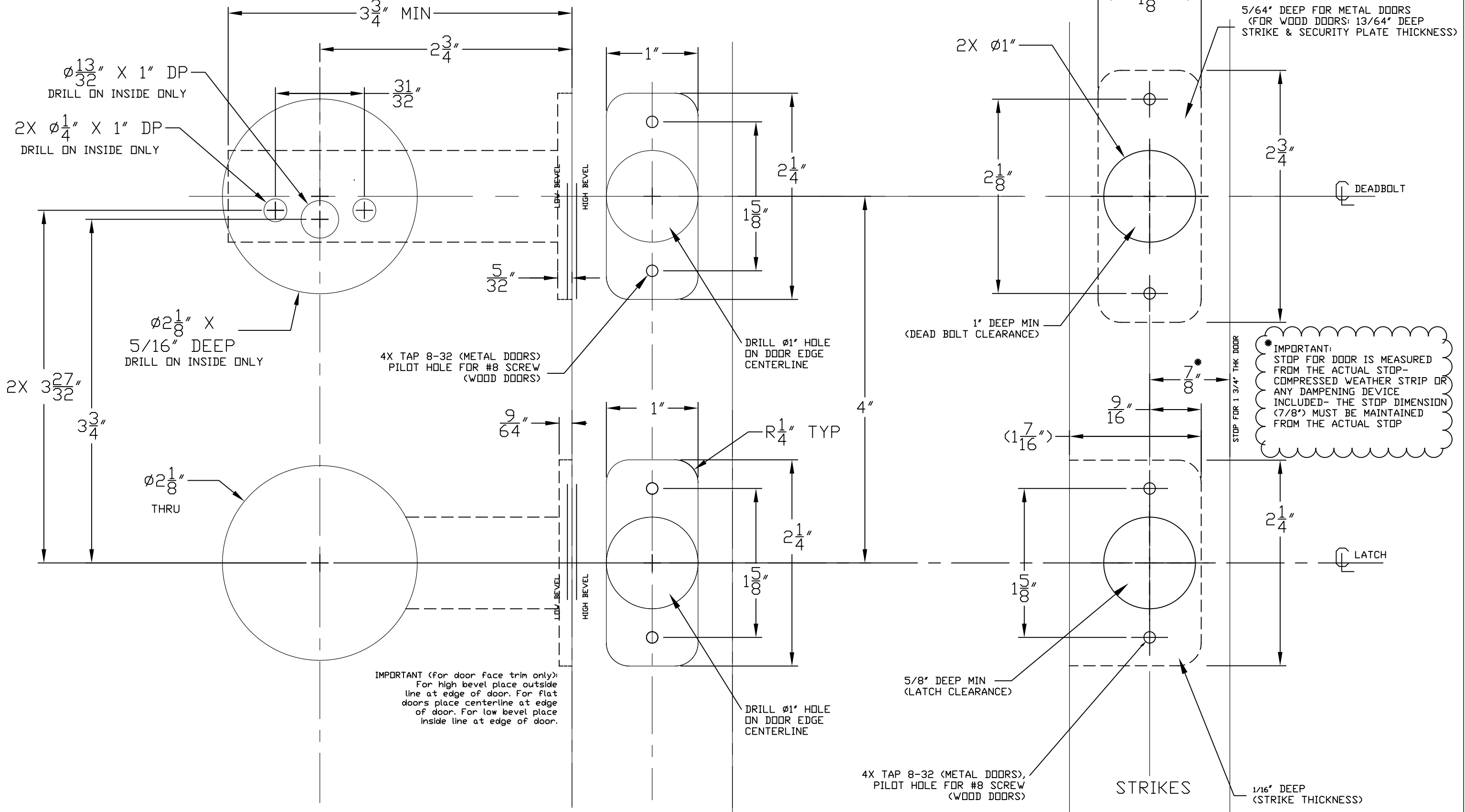

TEMPLATE SCALE IS 1:1 IF THIS MEASURES 1":

RESPONSIBILITY: Door and frame manufacturers are responsible for providing adequate construction or reinforcements for proper installation of hardware.

m-Genius-c 4" CTC TEMPLATE 2 3/4" BACKSET

5/64" DEEP FOR METAL DOORS
(FOR WOOD DOORS: 13/64" DEEP
STRIKE & SECURITY PLATE THICKNESS)

*** IMPORTANT:**
STOP FOR DOOR IS MEASURED
FROM THE ACTUAL STOP-
COMPRESSED WEATHER STRIP OR
ANY DAMPENING DEVICE
INCLUDED- THE STOP DIMENSION
(7/8") MUST BE MAINTAINED
FROM THE ACTUAL STOP

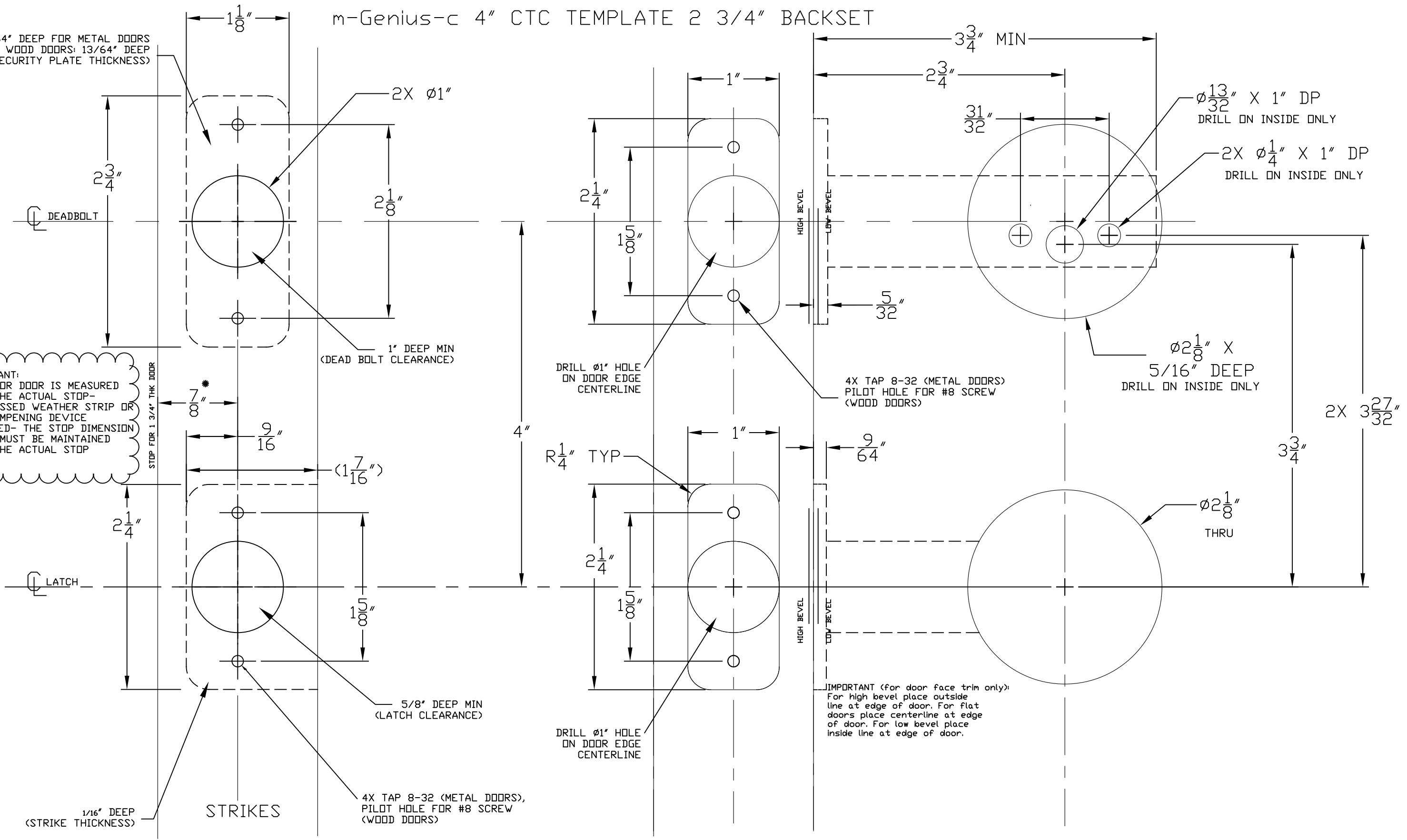

RESPONSIBILITY: Door and frame manufacturers
are responsible for providing adequate construction or
reinforcements for proper installation of hardware.

TEMPLATE SCALE IS 1:1 IF THIS MEASURES 1":