

MRX-L

ANSI Grade 1 Mortise Lock with Ligature Resistant Trim-Lever

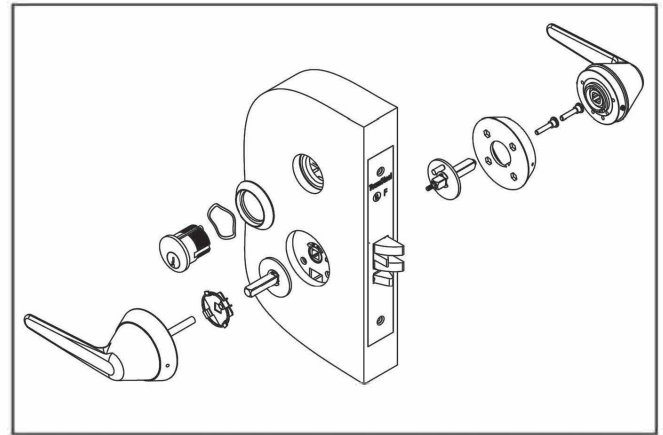

Specifications

- For facilities housing patients at risk
- For 1-3/4" door thickness, other upon request
- 2-3/4" backset
- Handed, field reversible
- 630 (US32D) finish
- Stainless steel rose (MRX-S-L), 2-3/4" in diameter
- Stainless steel escutcheon (MRX-E-L), 8"x3-1/4"x1/8"
- Stainless steel lever, ligature resistant
- Stainless steel turn piece, ligature resistant, ADA
- Stainless steel faceplate, 1-1/4" x 8"
- Stainless steel strike, ASA, 1-1/4" x 4-7/8"
- Through-bolt mounting, tamper resistant mounting screws, for wood and metal door
- Brass cylinder with stainless steel cover, 6 pin, Schlage "C" keyway standard, 2 keys per cylinder
- Small Format IC available with or without core, 6 or 7 pin core
- Schlage Large Format IC available in less core
- Corbin Large Format IC available in less core, for 6 pin core, Sargent Large format IC
- High Security Cylinder available, TownSteel "L" keyway, 6 pin
- High Security Small Format IC Core available, TownSteel "L" keyway, 7 pin
- 10-year limited warranty

Code Compliance

- ANSI/BHMA: A156.13 Grade 1 Certified
- UL/ULC: UL 10C Listed 3 Hour Fire Rating
- BAA: Meets requirements of the Buy American Act
- ADA: Meets requirements of the Americans with Disabilities Act



Important Note

It is TownSteel's position that if any of our keyed locks are to be used less cylinder, whether I.C. or standard, and another manufacturer's cylinder is to be used in place of the TownSteel original manufacturer's cylinder, that a sample of that product be provided to TownSteel in advance for testing.











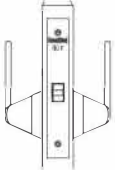



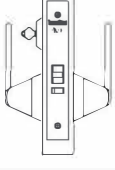

How To Order

Trim	MRX-E-L Ligature Resistant Lever Mortise-Escutcheon Trim MRX-S-L Ligature Resistant Lever Mortise-Sectional Trim	<div style="display: flex; justify-content: space-around; align-items: center;"> <div style="text-align: center;"> <p>Function</p> <p>MRX-E-L</p> <p>Trim</p> </div> <div style="text-align: center;"> <p>Handing</p> <p>- 04 -</p> <p>Cylinder</p> </div> <div style="text-align: center;"> <p>Function</p> <p>SFIC7</p> <p>Cylinder</p> </div> <div style="text-align: center;"> <p>Handing</p> <p>- LH</p> </div> </div>
Function	Please Refer to Function Sheet	
Cylinder	SC / SFIC6 / SFIC7 / CLFIC6 / SLFIC / L6 / L7	
Handing	LH / RH / LHR / RHR	

Functions

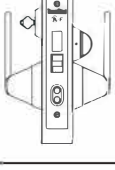
Ligature Resistant Mortise Series

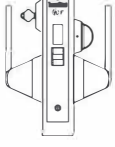
**Levers rotate up and down freely in the locked or unlocked positions*

Outside	Inside	Series/ Function	Type	ANSI No.	Function Description
		MRXL-01 MRXK-01 MRXA-01	Passage or Closet	F01	Latch bolt operated by lever from either side at all times.
		MRXL-02 MRXK-02 MRXA-02	Privacy or Bathroom	F02	Latch bolt operated by lever from either side. Dead bolt operated by turn from inside and emergency release from outside.
		MRXL-04 MRXK-04 MRXA-04	Entry/ Office	F04	Latch bolt operated by lever from either side, except when outside lever is made inoperative by a push button rocker. When outside lever is locked, latch bolt is retracted by key from outside or by operating inside lever. ***Auxiliary dead latch.
		MRXL-05 MRXK-05 MRXA-05	Classroom	F05	Latch bolt operated by lever from either side, except when outside lever is locked from outside by key. When outside lever is locked, latch bolt may be retracted by key, or by operating key and outside lever or by operating inside lever. ***Auxiliary dead latch.
		MRXL-07 MRXK-07 MRXA-07	Storeroom or Closet	F07	Latch bolt operated by key from outside or by rotating inside lever. Outside lever is always inoperative. ***Auxiliary dead latch.
		MRXL-08 MRXK-08 MRXA-08	Front Door or Corridor Lock	F08	Latch bolt operated by lever from either side, except when outside lever is made inoperative by a push button rocker. Dead bolt is operated by turn inside. Key outside operates both bolts.
		MRXL-12 MRXK-12 MRXA-12	Dormitory or Exit	F12	Latch bolt operated by lever from either side, except when outside lever is made inoperative by a push button rocker. Dead bolt projected by key from outside and by turn from inside. Deadbolt retracted by key from outside and by turn from inside. Operating inside lever retracts both bolts and outside remains locked.
		MRXL-13 MRXK-13 MRXA-13	Dormitory or Exit	F13	Latch bolt operated by lever from either side. Dead bolt projected by key from outside and thumb turn from inside. Operating inside lever retracts both bolts and unlocks outside.

Functions

Ligature Resistant Mortise Series











**Levers rotate up and down freely in the locked or unlocked positions*

Outside	Inside	Series/ Function	Type	ANSI No.	Function Description
		MRXL-14 MRXA-14	Store Door Lock	F14	Latch bolt operated by lever from either side. Dead bolt operated by key from either side.
		MRXL-15 MRXK-15 MRXA-15	Hotel or Motel	F15	Latch bolt operated by key from outside or by rotating inside lever. Outside lever is always inoperative. Dead bolt operated by thumb turn from inside and all keys except emergency and display key are shut out. Operating inside lever retracts both bolts. ***Auxiliary dead latch.
		MRXL-19 MRXK-19 MRXA-19	Privacy or Bathroom	F19	Latch bolt operated by lever from either side. Dead bolt operated by turn from inside and emergency release from outside. Operating inside lever retracts both bolts.
		MRXL-20 MRXK-20 MRXA-20	Apartment/ Corridor	F20	Latch bolt operated by lever from either side, except when outside lever is made inoperative by push button rocker. Dead bolt projected by key from outside and by thumb turn from inside. Key outside operates both bolts. Operating inside lever retracts both bolts and outside remains locked. Latch bolt is deadlocked when outside lever is made inoperative or when the dead bolt is projected. When dead bolt is retracted, lever is unlocked by stop or mechanical means other than key.
		MRXL-22 MRXK-22 MRXA-22	Privacy	F22	Latch bolt operated by lever from either side, except when outside lever is locked by inside turn. Operating inside lever, closing door or operating outside emergency release unlocks outside lever.
		MRXL-26 MRXK-26 MRXA-26	Institutional Privacy	F26	Latch bolt operated by lever from either side except when outside lever is locked by turn inside. Latch bolt operated by key outside with override of turn inside when manually held in locked position. Operating inside lever or closing door unlocks outside lever. ***Auxiliary dead latch.
		MRXL-29 MRXK-29 MRXA-29	Classroom Dead Lock	F29	Key from outside operates dead bolt. Turn from inside retracts but does not project dead bolt.
		MRXL-30 MRXK-30 MRXA-30	Institutional	F30	Latch bolt operated by key either side. Both levers always inoperative. ***Auxiliary dead latch.

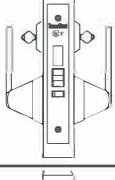
Functions

Ligature Resistant Mortise Series

**Levers rotate up and down freely in the locked or unlocked positions*

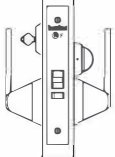
Outside	Inside	Series/ Function	Type	ANSI No.	Function Description
		MRXL-32 MRXK-32 MRXA-32	Intruder Latch bolt	F32	Latch bolt operated by lever either side, except when outside lever is locked from inside or outside by key. When outside lever is locked, latch bolt is retracted by key from inside or outside or by operating inside lever. ***Auxiliary dead latch
		MRXL-33 MRXK-33 MRXA-33	Intruder Dead bolt	F33	Latch bolt operated by lever either side, except when outside lever is locked from inside or outside by key. Dead bolt operated by key either side. Inside lever retracts both bolts and unlocks outside lever.
		MRXL-34 MRXK-34 MRXA-34	Intruder Dead bolt	F34	Latch bolt operated by lever either side, except when outside lever is locked from inside or outside by key. Dead bolt operated by key either side. Operating inside lever retracts both bolts and unlocks outside. *** Auxiliary dead latch or latch bolt dead locked when dead bolt is thrown.
		MRXL-35 MRXK-35 MRXA-35	Storeroom with Dead bolt	F35	Latch bolt operated by lever from either side, except when outside lever is made inoperative by a push button rocker. Dead bolt operated by key from either side.
		MRXA-41	Single Dummy	F41	Dummy trim on one side, blank plate on the other side.
		MRXL-46 MRXK-46	Institutional Privacy with key locked feature		Latch bolt operated by lever from either side except when outside lever is locked by turn inside or key outside. Latch bolt operated by key outside with override of turn inside when manually held in locked position. Operating inside lever or closing door unlocks outside lever. ***Auxiliary dead latch.
		MRXA-72	Back to back Double Dummy	F72	Dummy trim on both sides.
		MRXL-RF MRXK-RF	Female Privacy RF		Latch bolt operated by lever from either side except when outside lever is locked from outside by key or inside turn. When outside lever is locked latch bolt may be retracted by inside lever or outside lever when unlocked by key. Inside lever retracts the latch bolt but does not unlock the outside lever.
		MRXL-LTF MRXK-LTF	Female Privacy LTF		Latch bolt operated by lever from either side except when outside lever is locked from outside by key or inside turn. When outside lever is locked latch bolt may be retracted by inside lever or outside lever when unlocked by key. Operating the inside lever or closing the door unlocks the outside lever.