

# INSTALLATION INSTRUCTIONS COMMERCIAL KEY-IN-LEVER

**FOR USE ON DOORS 1-3/8"~2"  
(35mm-51mm) THICK**

**TOOLS REQUIRED FOR NEW INSTALLATION:**

- 1 philips head screwdriver
- 1 2-1/8" (54mm) hole saw
- 1 1" (25.4mm) drill bit
- 1 5/16" (8mm) drill bit
- 1 chisel

**TOOLS REQUIRED FOR REPLACEMENT:**

- 1 philips head screwdriver

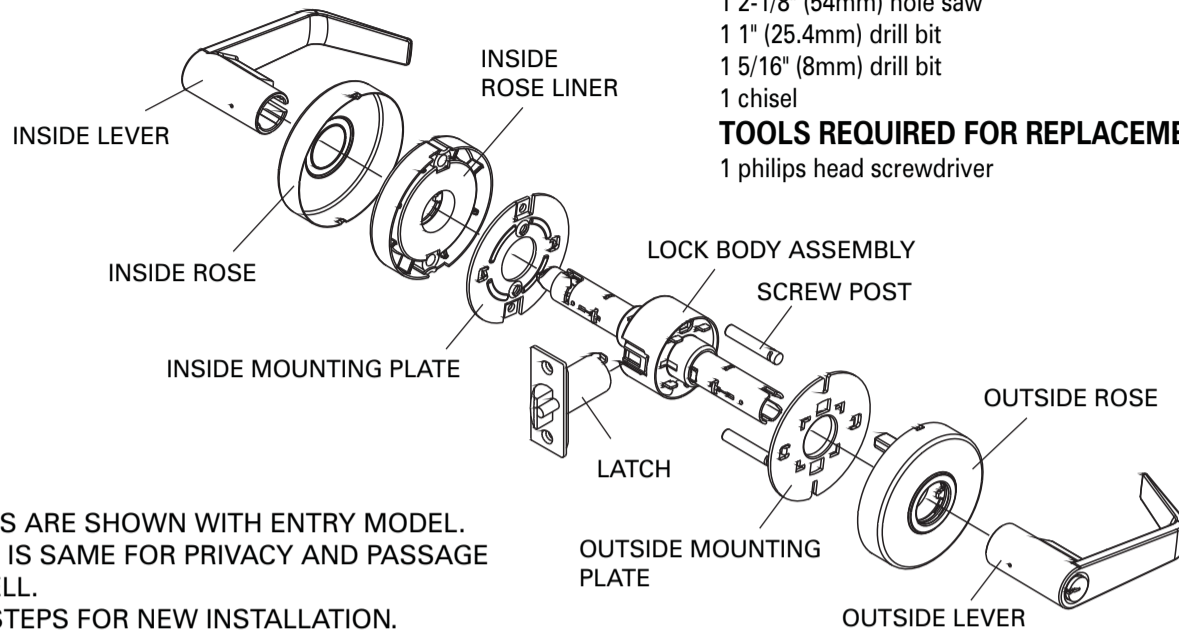

ILLUSTRATIONS ARE SHOWN WITH ENTRY MODEL.  
INSTALLATION IS SAME FOR PRIVACY AND PASSAGE  
MODEL AS WELL.  
FOLLOW ALL STEPS FOR NEW INSTALLATION.  
FOLLOW STEPS 3C,4C,5,6,7,8,9  
FOR REPLACEMENT INSTALLATION AFTER REMOVAL  
OF OLD LOCK AND LATCH.

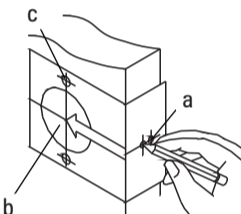
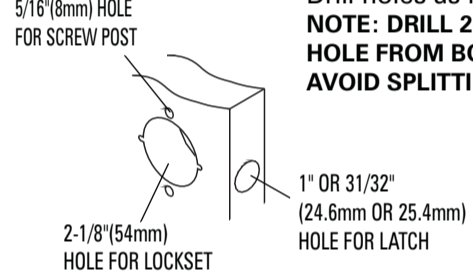
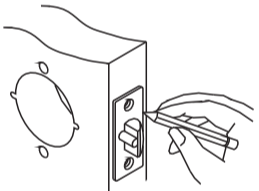
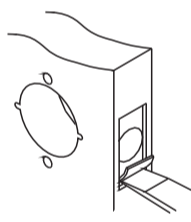
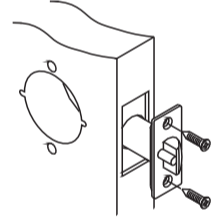
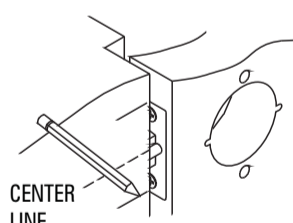
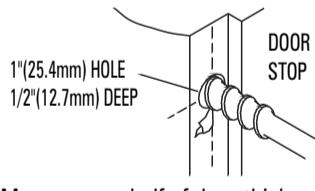
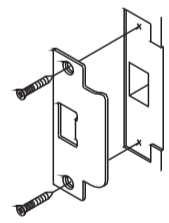
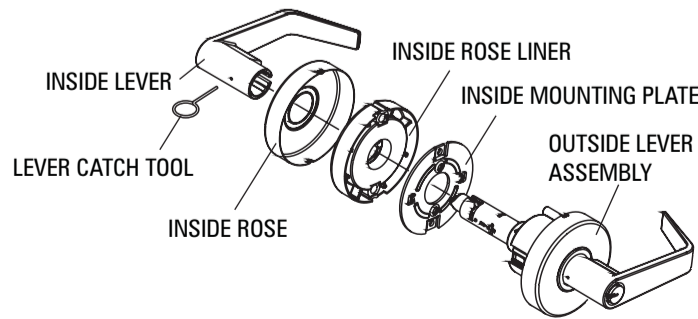
<p><b>1. MARK DOOR</b></p>  <p>a. Start 38" from floor and mark center of door edge. b. Select backset 2-3/8" or 2-3/4" and mark hole center on door face. c. Mark two holes for screw post.</p> <p><b>NOTE: BACKSET ON DOOR FACE MUST BE SAME AS BACKSET OF YOUR LOCK.</b></p>		<p><b>2. DRILL HOLES</b></p>  <p>Drill holes as marked. <b>NOTE: DRILL 2-1/8" (54mm) HOLE FROM BOTH SIDES TO AVOID SPLITTING WOOD.</b></p>	
<p><b>3. INSTALL LATCH</b></p>  <p>a. Insert latch in hole and keep it parallel to door face. Mark outline and remove latch.</p>  <p>b. Chisel 1/8" (3mm) deep or until faceplate flush with door edge.</p>  <p>c. Insert latch and tighten screws. <b>NOTE: LATCHBOLT BEVEL MUST FACE TO CLOSING DIRECTION.</b></p>			
<p><b>4. INSTALL STRIKE</b></p>  <p>a. Close door to mark horizontal center line of strike.</p>  <p>b. Measure one half of door thickness from door stop to mark vertical center line of strike. Drill 1" (25.4mm) hole, 1/2" (12.7mm) deep at intersection of horizontal and vertical center lines.</p>  <p>c. Cut out jamb 3/32" (2.4mm) deep or until strike flush with jamb. Tighten screws securely.</p>			
<p><b>5. REMOVE INSIDE TRIM</b></p> <p>Use lever catch tool to depress lever catch visible under hole of inside lever shank and slide off inside lever, rose, rose liner and mounting plate.</p> 			

**6. INSTALL REMOVABLE THRU-BOLT (SCREW POST)**

- a. Disassemble outside mounting plate from outside rose plate.
- b. Make clearance between outside mounting plate and insert the removable thru-bolt (screw post) into the cavities of outside mounting plate.
- c. Continuing the follow up instructions.

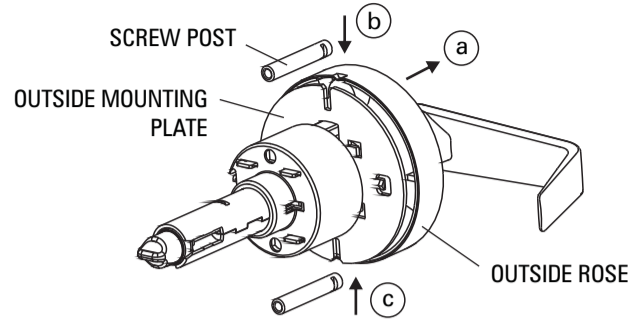

**7. ADJUST DOOR THICKNESS**

- a. Remove outside mounting plate toward cylindrical case.
- b. Put the catch tool into the allocated position of outside mounting plate as the illustrating bellow.
- c. Rotate outside mounting plate to required door thickness by using a catch tool.

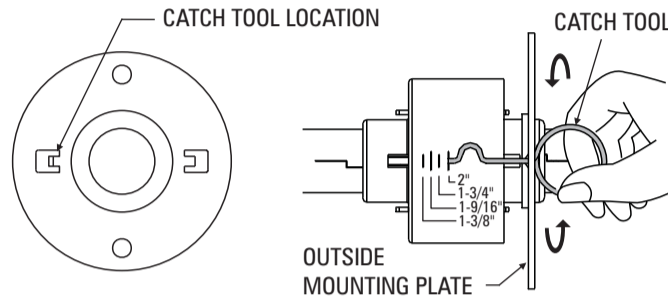

**8. INSTALL OUTSIDE LEVER ASSEMBLY**

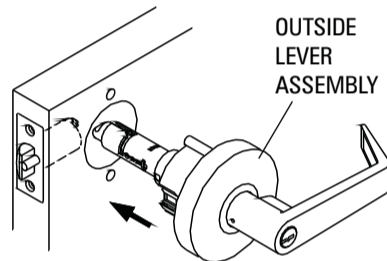
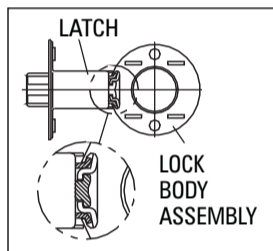

Install outside lever assembly on the door. Make sure tail of latch engaging with retractor correctly as illustration left.

**9. INSTALL INSIDE MOUNTING PLATE AND ROSE LINER**

- a. Place mounting plate on door face and turn up the lever slightly and tighten screws securely.

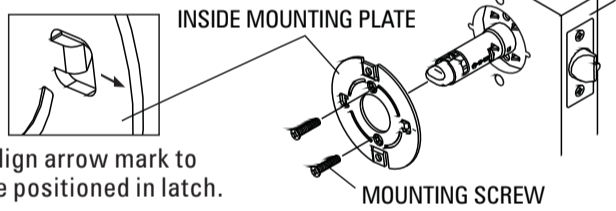

Align arrow mark to be positioned in latch.

**10. INSTALL INSIDE ROSE AND LEVER**

- a. Press rose onto rose liner. Be sure to fit rose in recess of rose liner.

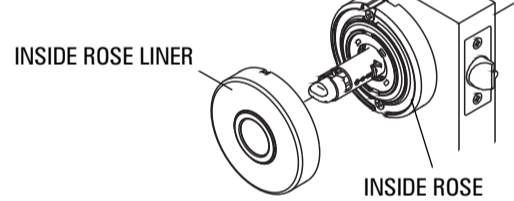

- b. Place rose liner on mounting plate and tighten with screw securely.

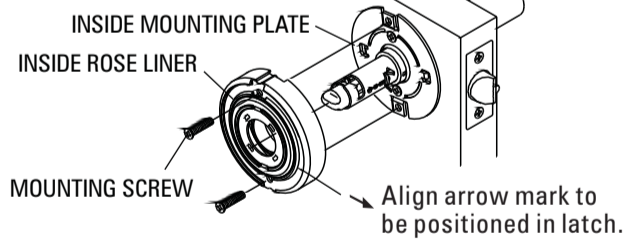

Align arrow mark to be positioned in latch.

- b. Use lever catch to press down catch in the hole and push inside lever all the way in until clicks into catch hole.

